

# Data Sheet

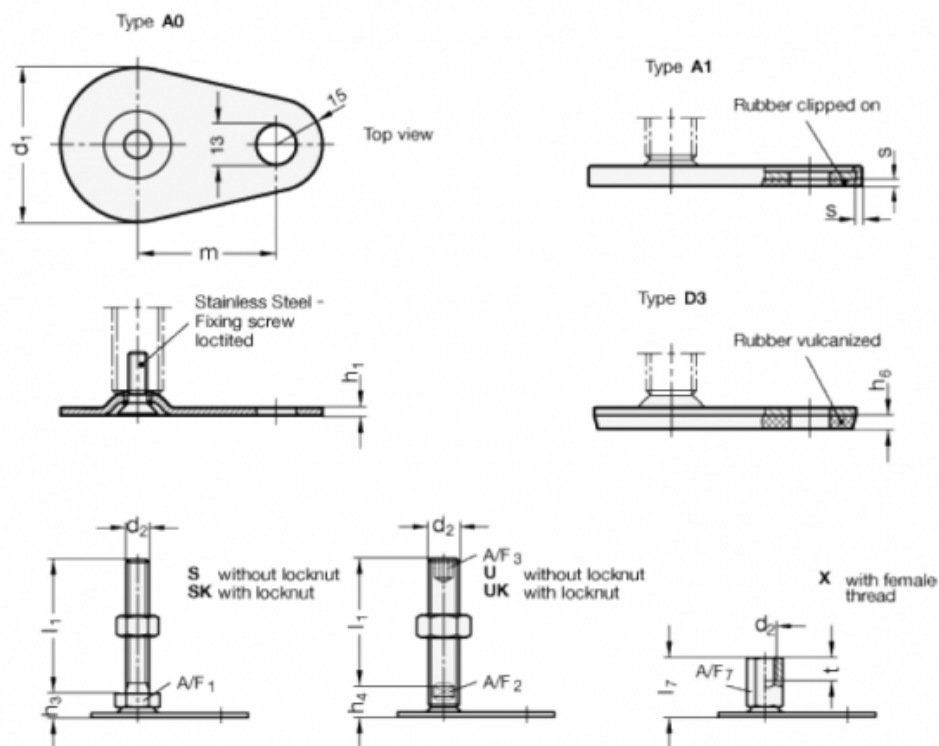

Article number: 204250M1232A1X  
Description: E+G levelling foot  
GN 42-50-M12-32-A1-X  
Note: X With female thread, External hexagon

## Measures



A/F7 = 17

t = 12

d1 = 50

d2 = M12

h1 = 2.5

h6 =

l7 = 32

m = 45

s = 2